

LA SYMÉTRIE

1) Colorie les figures qui sont symétriques par rapport au trait rouge.

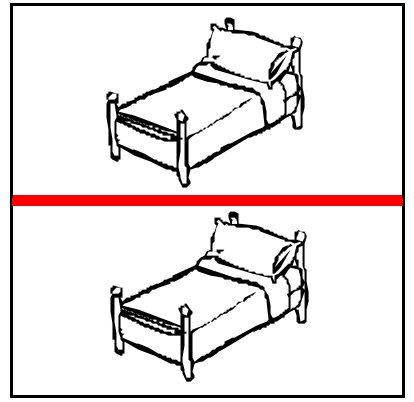

2) Dessine, quand c'est possible, le trait de pliage sur les figures ci-dessous.

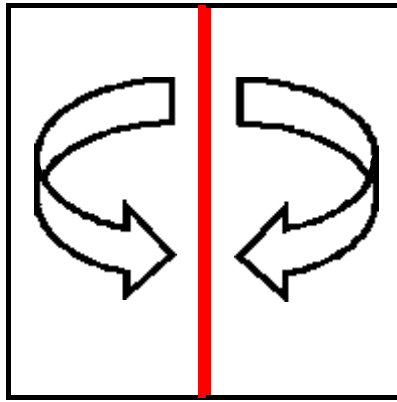
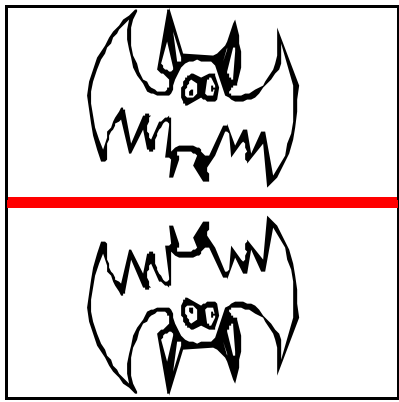
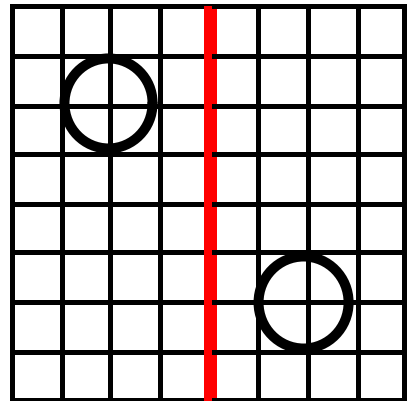
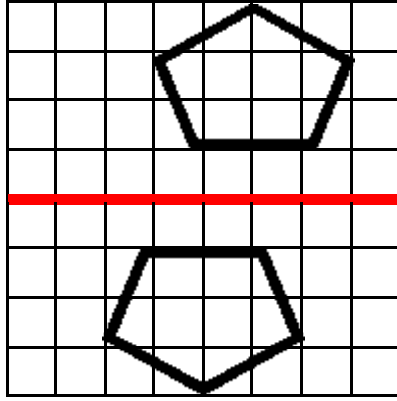
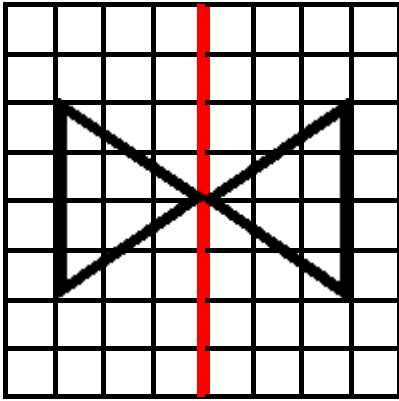
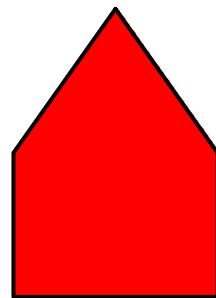
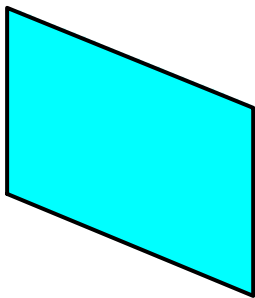
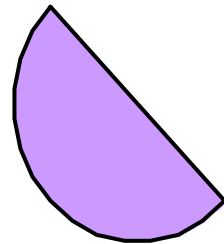
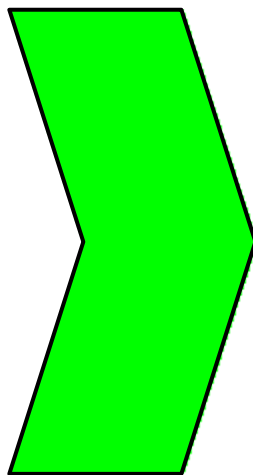
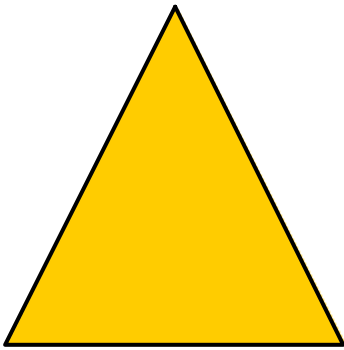

LA SYMÉTRIE
SOLUTION

1) Colorie les figures qui sont symétriques par rapport au trait rouge.

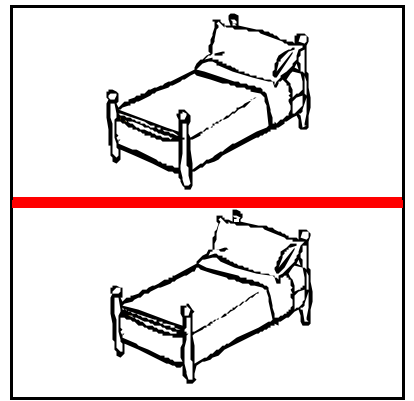
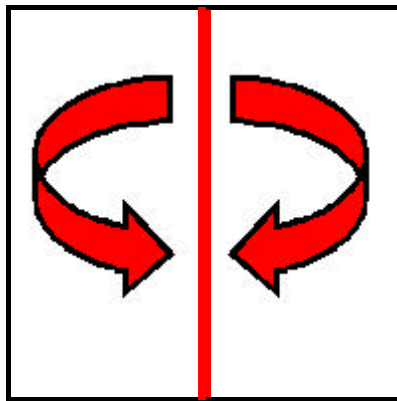
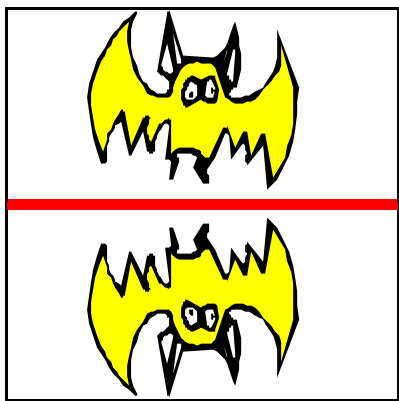
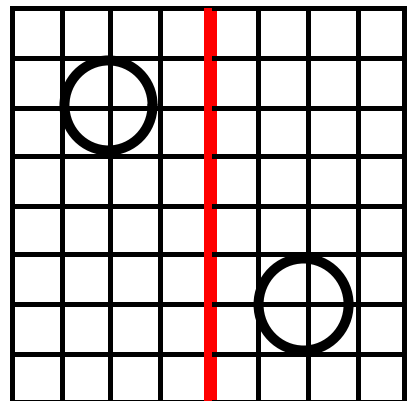
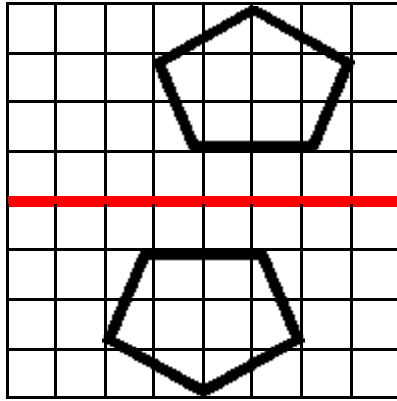
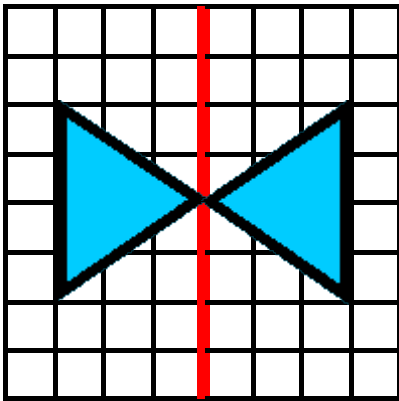

2) Dessine, quand c'est possible, le trait de pliage sur les figures ci-dessous.

